

RULLO
GUFO
ROLLER
GUFO

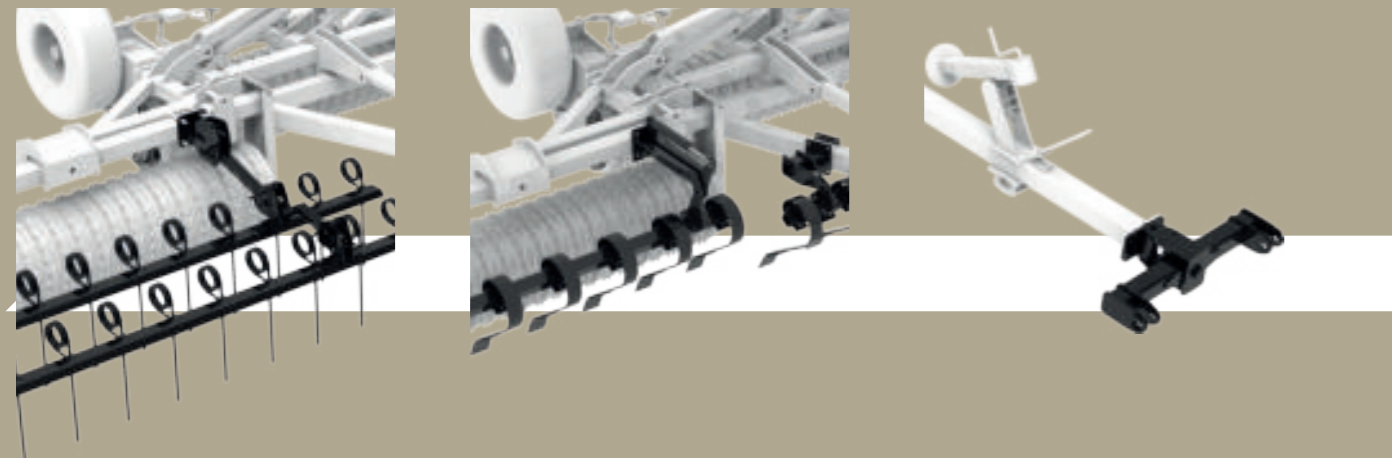

VOLGARINO
MACCHINE AGRICOLE



DOPPIO ERPICE A MOLLE ANTERIORE MANUALE
MANUAL DOUBLE FRONT SPRING HARROW

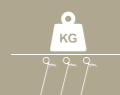

CODICE CODE	MODELLO MODEL	PESO WEIGHT (KG)
AP195	430	265
AP198	530	300
AP200	630	340
AP202	730	370
AP204	830	550

LAMA LIVELLATRICE ANTERIORE IDRAULICA
HYDRAULIC FRONT LEVELING BLADE



CODICE CODE	MODELLO MODEL	PESO WEIGHT (KG)
AP196	430	350
AP199	530	400
AP201	630	425
AP203	730	475
AP205	830	500

BARRA STERZANTE
STEERING BAR

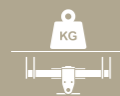

CODICE CODE	MODELLO MODEL	PESO WEIGHT (KG)
AP197	430	70
AP197	530	70
AP197	630	70
AP197	730	70
AP197	830	70

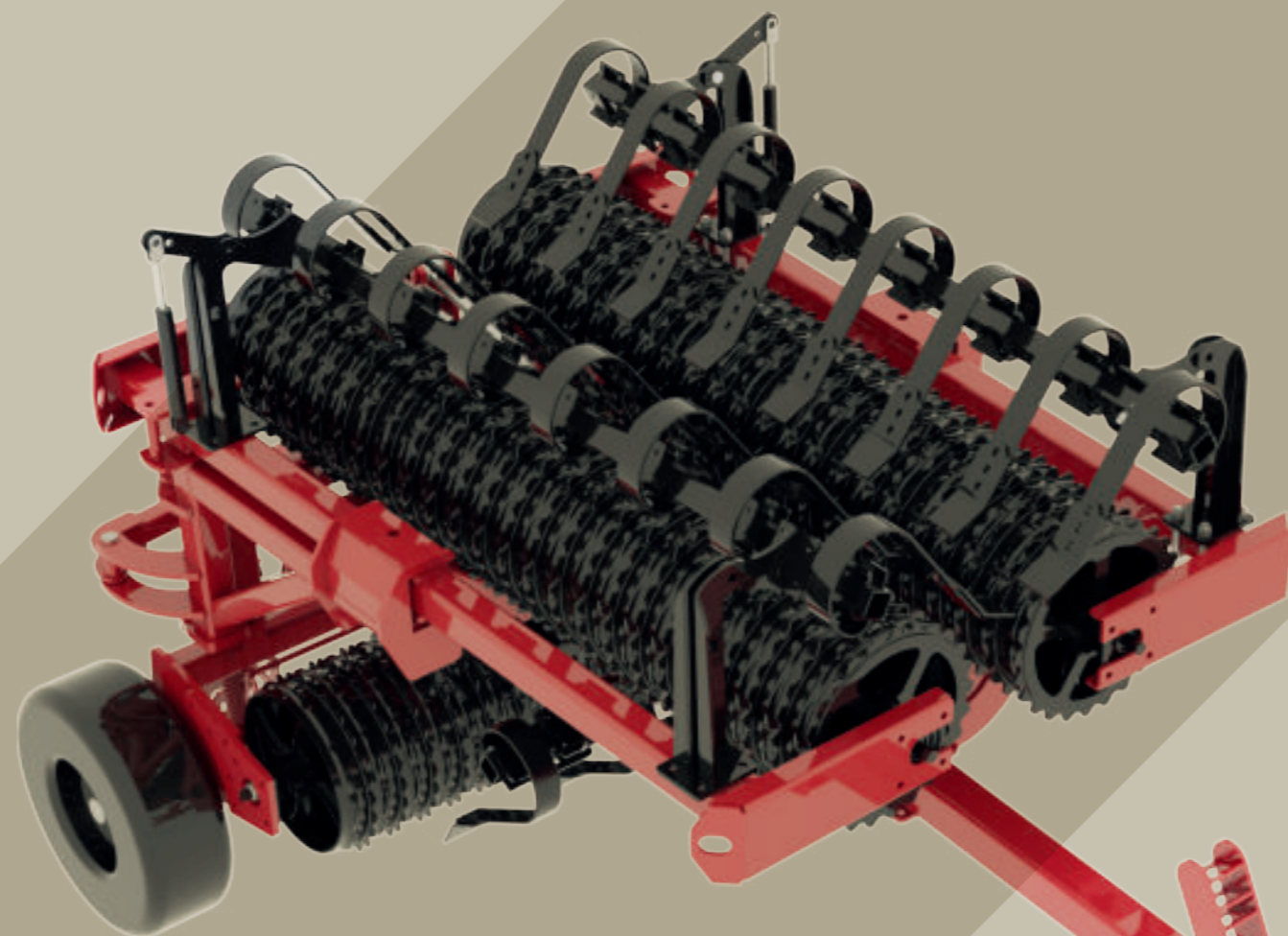

GUFO
RULLI

GUFO
ROLLERS



WWW.VOLGARINO.COM

VOLGARINO
MACCHINE AGRICOLE



Via Michele Di Pumpo
71017 Torremaggiore FG
info@volgarino.com
(+39) 0882 38 21 41

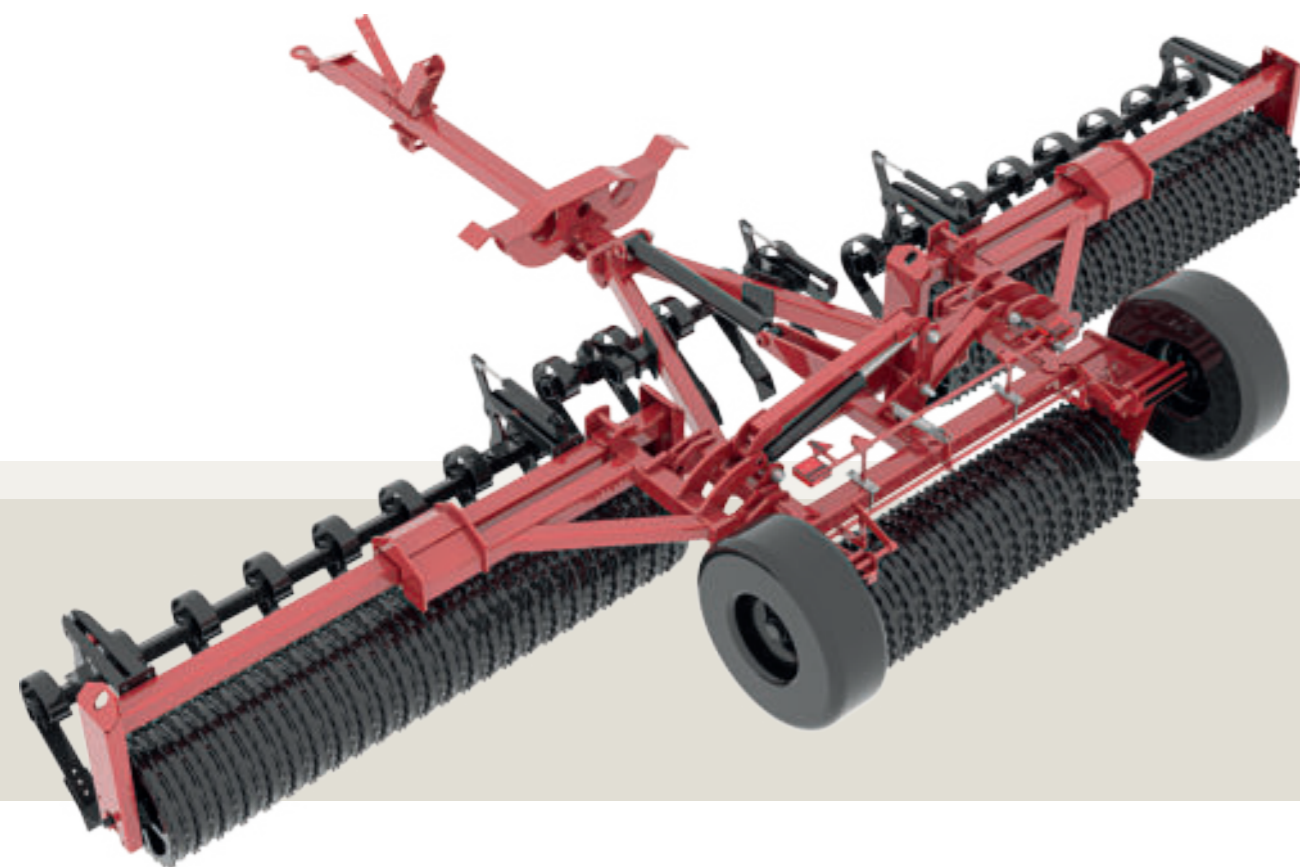

DOTAZIONI DI SERIE
STANDARD EQUIPMENT

A Disco Cambridge Standard Diametro 530 mm Standard Cambridge disc diameter 530 mm	F Telaio in acciaio ad alta resistenza Ultra high-strength steel structure
B Elementi dei rulli oscillanti che seguono il profilo del terreno Elements of swaying rollers that follow the contour of the ground	G Sistema automatico di blocco delle sezioni in posizione trasporto Automatic blocking system while in transportation
C Supporto cuscinetti in acciaio Steel bearing support	H Apertura e chiusura idraulica del telaio Hydraulic opening and locking of the chassis
D Ruote tipo 10.0/75x15.3 (mod. 430/530/630) Ruote tipo 11.5/80x15.3 (mod. 730/830) Wheel type: 10.0/75x15.3 (model 430/530/630) Wheel type: 11.5/80x15.3 (model 730/830)	I Omologazione al traino (mod. 530/630) Towing homologation (mod. 530/630)
E Occhione girevole Towing eye	

ACCESSORI PRINCIPALI
MAIN ACCESSORIES

DOPPIO ERPICE A MOLLE ANTERIORE MANUALE
MANUAL DOUBLE FRONT SPRING HARROW

LAMA LIVELLATRICE ANTERIORE IDRAULICA
HYDRAULIC FRONT LEVELING BLADE

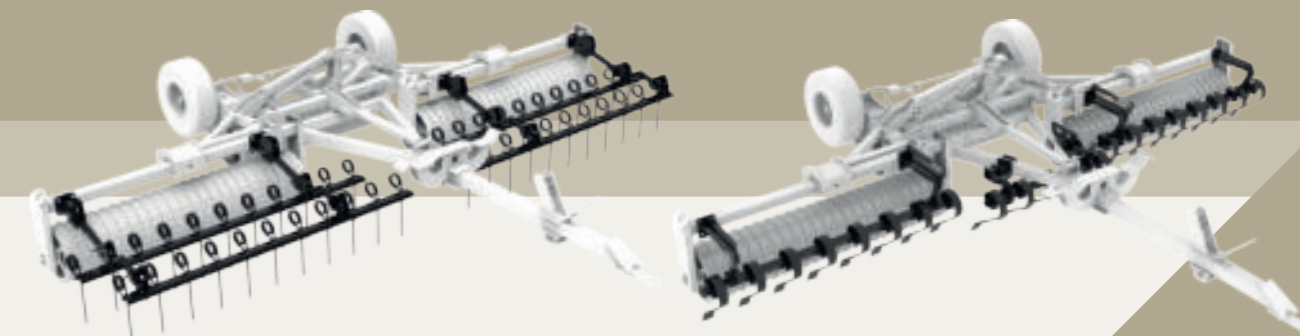

BARRA STERZANTE
STEERING BAR



LAVORAZIONE E TRASPORTO
WORKING AND TRANSPORT

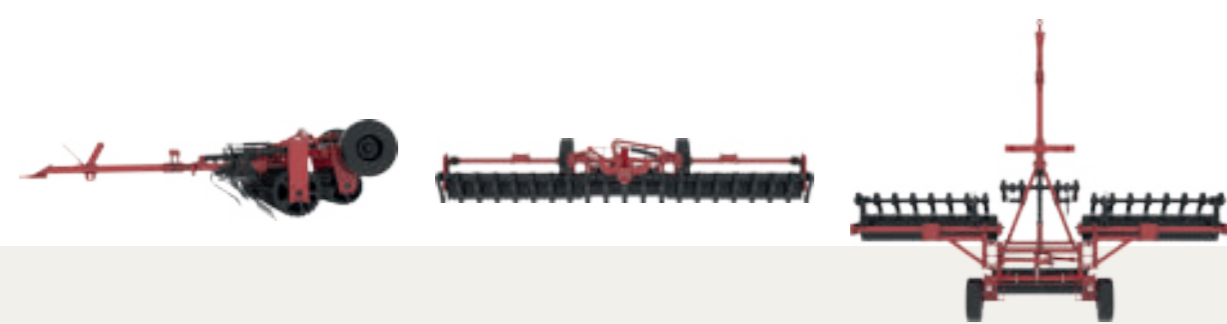
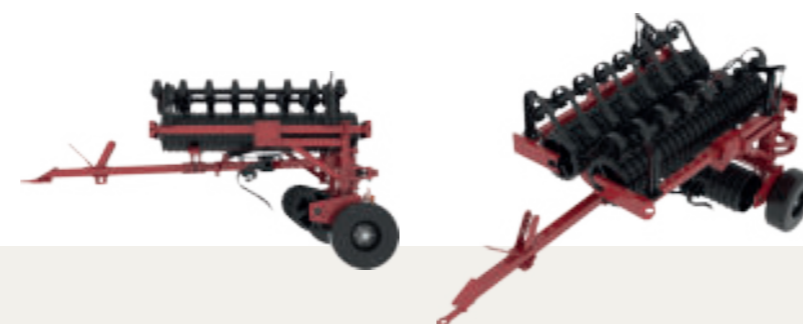

CARATTERISTICHE
FEATURES

NOME NAME	MODELLO MODEL	POTENZA MIN-MAX POWER MIN-MAX (HP)	PESO WEIGHT (KG)
GUF430	430	80	2.665
GUF530	530	90	3.055
GUF630	630	110	3.345
GUF730	730	130	3.700
GUF830	830	160	4.300



LARGHEZZA LAVORO WORKING WIDTH (MM)	INGOMBRO STRADALE ROAD SIZE (MM)
4.300	2.500
5.300	2.500
6.300	2.500
7.300	2.500
8.300	2.500

ALTRI ACCESSORI
OTHER ACCESSORIES

H Kit segnaletica
Signage kit



Dettagli nella sezione Altri Accessori
Details in the Other Accessories section

H